

instruction, maintenance & experiment manual

RADIOLOGICAL DEMONSTRATION UNIT

OCDM Item No. CD V-457, Model No. 2

NUCLEONIC CORPORATION OF AMERICA
BROOKLYN 31, NEW YORK

C O N T E N T S

<u>Paragraph</u>	<u>Subject</u>	<u>Page</u>
 <u>PART I</u> 		
Section 1 PRECAUTIONS		
		1
 Section 2 GENERAL DESCRIPTION		
1.	Scope of Manual, Part I	1
2.	Purpose	2
3.	Description	4
3a	G-M Detector Tube	4
3b	Probe and Cable Assembly	10
3c	Radiological Demonstration Instrument.	10
3d	Calibrated Mounting Board.	13
3e	Radium Beta-Gamma Source	13
3f	Flat and Cylindrical Absorbers	14
 Section 3 THEORY OF OPERATION		
1.	Input Circuit	14
2.	Ratemeter Circuit	17
3.	Audio Circuit	18

<u>Paragraph</u>	<u>Subject</u>	<u>Page</u>
	Section 3 (cont'd)	
4.	Power Supply Circuit	18
5.	Chart Recorder Circuit	19
	Section 4 INSTALLATION	
1.	Unpacking the Equipment	20
2.	Operating the Demonstration Unit	22
	Section 5 OPERATION	
1.	Using the Instrument for General Survey	23
2.	Measuring Beta and Gamma Radiation	23
3.	Connecting a Strip-Chart Recorder	24
	Section 6 OPERATOR'S MAINTENANCE	
1.	Replacing the Fuse	24
2.	Replacing the Geiger Tube	25
	Section 7 PREVENTIVE MAINTENANCE	
	Section 8 CORRECTIVE MAINTENANCE	
1.	General	26
2.	Preliminary Checks	26
3.	Localization of Faults	27
4.	Calibration Procedure	27

<u>Paragraph</u>	<u>Subject</u>	<u>Page</u>
	Section 9 PARTS LIST	33
	PART II	
	Section 1 BACKGROUND	
1.	History of Radioactivity	46
2.	Radioactive Decay	46
3..	Nuclear Radiations	48
	Section 2 EXPERIMENTS	
1.	G.M. COUNTER CHARACTERISTICS	51
1a	G.M. Plateau	51
1b	Resolving Time	53
2.	STATISTICS OF RADIOACTIVE DECAY PROCESS	56
3.	THE PROPAGATION, ABSORPTION AND SCATTERING OF RADIATION	61
3a	The $1/r^2$ Law	62
3b	The Absorption of Radiation	65
3c	The Scattering of Radiation	66

<u>Figure</u>	<u>Title</u>	<u>Page</u>
1.	Radiological Demonstrator Unit	3
2.	Halogen-Quenched G-M Tube	5
3.	Typical Plateau Curve of Halogen-Quenched G-M Tube.	8
4.	Front and Rear Panel Views of Demonstration Unit . .	12
5.	Schematic Diagram of Demonstration Unit	15
6.	Shipping and Storage Case	21
7A	Top View of Demonstration Unit Chassis	31
7B	Bottom View of Demonstration Unit Chassis	32

T A B L E S

<u>Number</u>	<u>Title</u>	<u>Page</u>
I	Components of Radiological Demonstration Unit	2
II	Trouble-Shooting Chart	29
III	Voltage and Resistance Measurements	30

Section I

PRECAUTIONS

High voltages exist in this equipment, and dangerous radiations may be encountered when using this equipment.

Follow standard radiological safety measures in the use of this equipment. The following tabulation lists all specific precautions which should be observed.

- (1) Do not handle the radioactive source unnecessarily. While the radiation intensity of the source is relatively low in terms of bodily hazard, the source should only be handled as required for operating the equipment and performing the experiments outlined herein.
- (2) High voltages are present in the geiger tube (900) volts and in the plate circuit of vacuum tube V4 (2000 volts). Although these voltages have extremely low current ratings, only authorized personnel should attempt to disassemble or repair the instrument.
- (3) The instrument requires 100-120 volts, 50-60 cycles A-C power. Do not connect the instrument to an improper source.

Section 2

GENERAL DESCRIPTION

1. Scope of the Manual, Part I

- Part I of the manual contains information related to the installation, operation, theory, and maintenance of Radiological Demonstration Unit, OCDM Item No. CD V-457, Model No.
2. Table 1 below is a listing of the contents of the shipping and storage case and reference numbers which are shown in Figure 1.

Table 1

COMPONENTS OF RADIOLOGICAL DEMONSTRATOR UNIT

<u>COMPONENTS</u>	<u>QUANTITY</u>	<u>REF. NO.</u>
Shipping and Storage Case	1	1
Padlock, 2 keys	1	2
Radiological Demonstration Unit	1	3
Probe and Cable Assembly	1	4
Accessories		
Spare GM Tube, OCDM Type 6993	1	5
Calibrated Mounting Board	1	6
Radium Beta-Gamma Sources	2	7
Flat Aluminum Absorbers	14	8
Flat Cardboard Absorbers	20	9
Flat Lead Absorbers	10	10
Cylindrical Aluminum Absorber	1	11
Cylindrical Cardboard Absorber	1	12
Cylindrical Lead Absorber	1	13
Film Container	1	14
Instruction Manual	2	15
OCDM Radiological Instruments (These items may be shipped separately)		
Dosimeters, CD V-138	25	16
Chargers, CD V-750	3	17
Food and Water Standards CD V-787	10	18

2. Purpose

The Radiological Demonstration Unit and associated components are intended for use in measuring radiation intensities and for demonstrating basic radiation physics. The

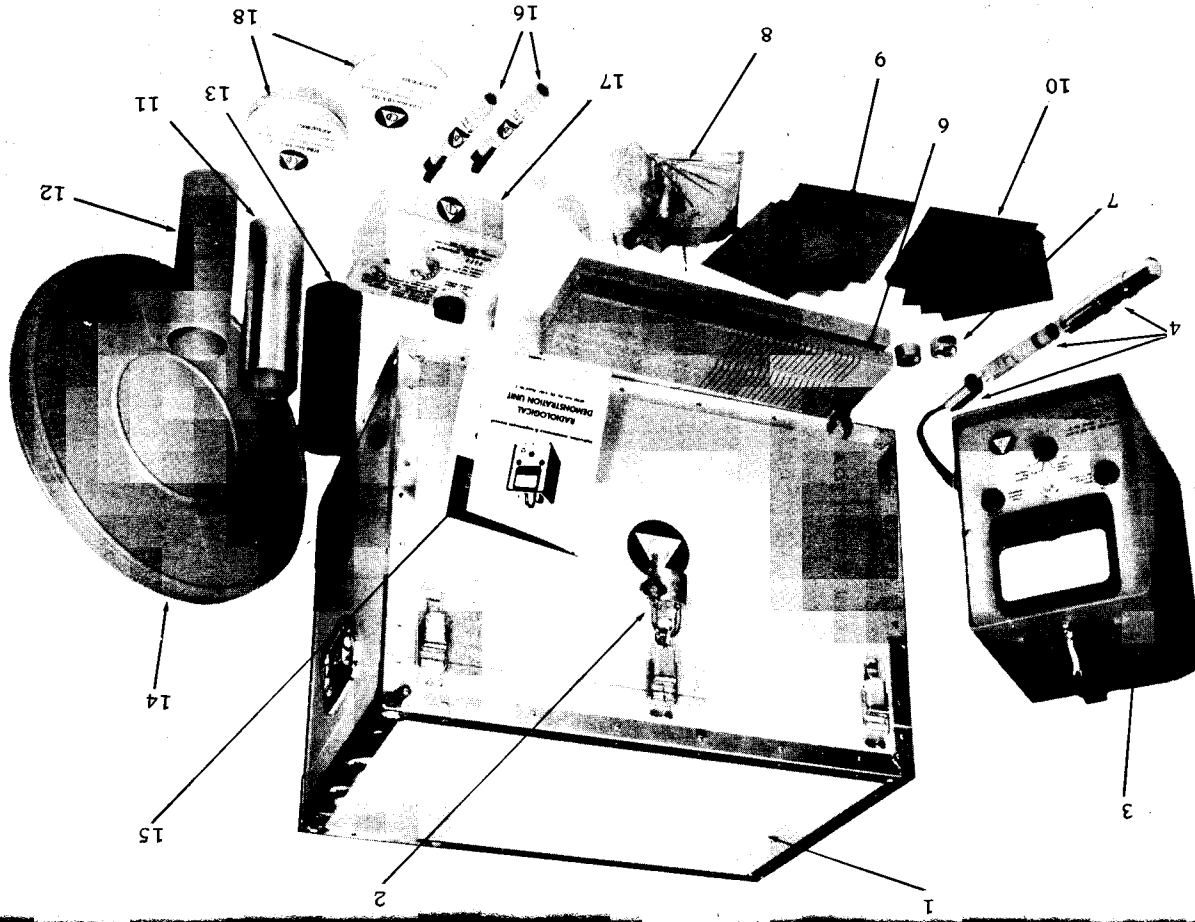

instrument can be used in a wide variety of applications such as checking apparatus, equipment, and areas for contamination in radiation safety measurements.

3. Description

As indicated in Table I and Figure 1, the complete storage case contains a Demonstration Unit, accessories, and standard OCDM Radiological Instruments. A description of the major components is presented below together with a brief summary of how these instruments are used in the study of radioactivity.

a. G-M Detector Tube

The G-M Detector Tube, shown as part of Item 4 in Figure 1, is a gas-filled metal tube designed to detect beta and gamma radiations emanating from radioactive materials. It is 3-3/4" in length and has a diameter of 5/8". As shown in Figure 2, the tube consists of two electrodes: a fine metal wire (anode) located in the center of the tube and an outer cylindrical cathode, part of whose length is thinned. The tube is filled with a small amount of halogen gas and an inert gas such as argon. In operation, a potential difference of approximately 900 volts is maintained between the anode and the cathode, with the anode always positive.

The principle of operation of the geiger tube is based on its ability to detect the formation of ions caused by nuclear radiation, which may consist of high energy rays or electrically charged particles originating in the nuclei of atoms. When a nuclear ray or particle passes close to an atom, it has sufficient energy to dislodge an electron from the outer orbit of the atom. Originally, the atom was electrically neutral; however, the removal of the negative

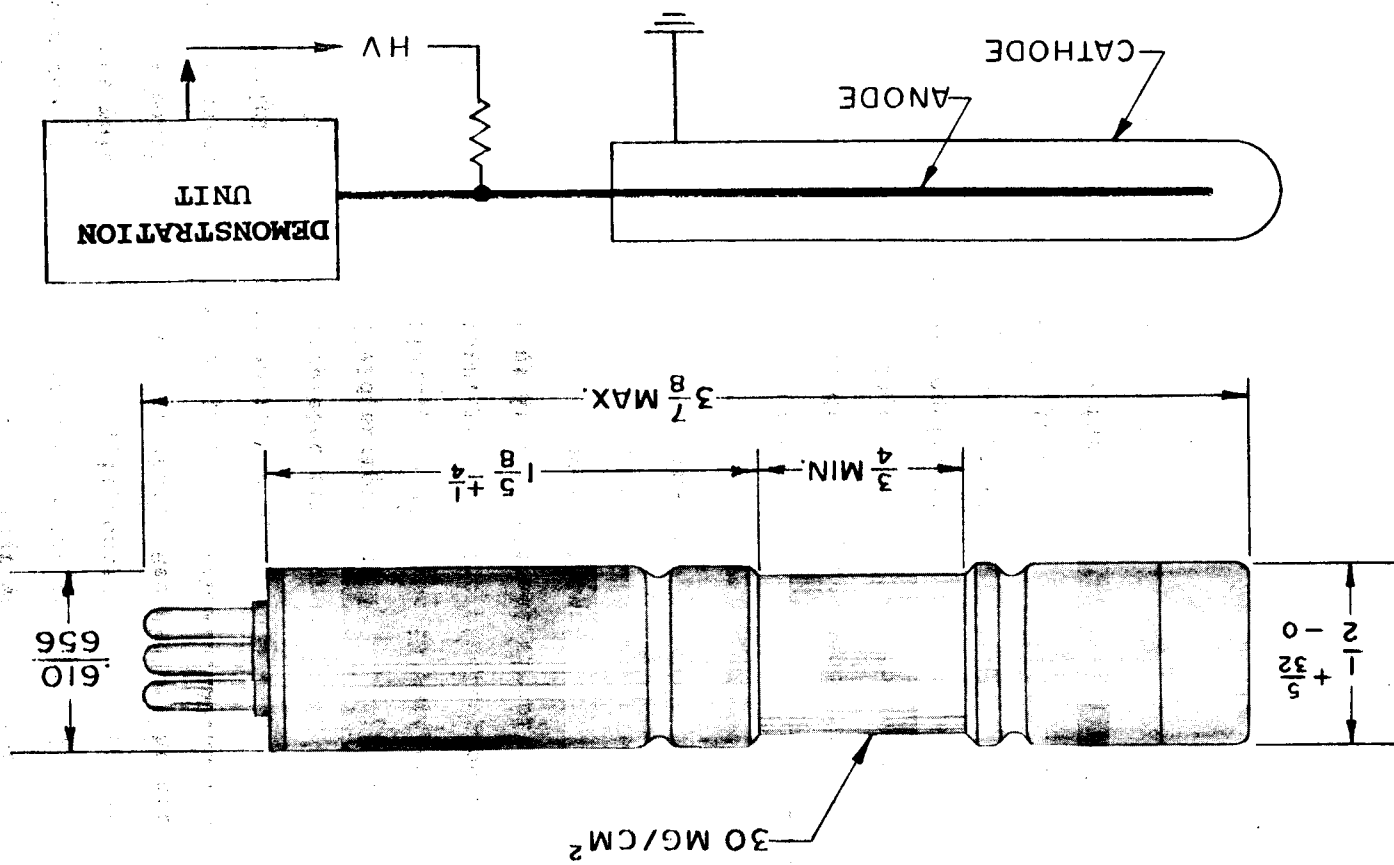

Figure 2 HALOGEN-QUENCHED G-M TUBE

electron converts the atom to a positively charged ion.

Keeping the above in mind, consider what happens when a nuclear ray or particle enters the geiger tube. As it passes close to gas molecules in the tube, it ionizes the molecules and creates positive ions and electrons. Because of the high voltage maintained in the tube, these positively and negatively charged particles are attracted to the oppositely charged electrodes. Since the positive electrode (anode) is a fine wire, the intensity of the field surrounding it is very high. Attracted by this powerful field, one electron is sufficiently accelerated to produce, in turn, an avalanche of electrons, resulting in a surge of current in the external circuit connected to the tube. Each surge or pulse of current is amplified in the radioactivity demonstrator and causes a measurable deflection of the meter needle of the instrument.

The geiger tube is designed to deliver only one pulse of current for each nuclear ray or particle that activates it. This is accomplished in several different ways depending on the type of tube being used. In the case of a halogen-quench tube, as is supplied with this equipment, a very small amount of halogen gas such as bromine or chlorine is added to the inert gas (argon) that fills the tube. The purpose of this quenching gas is to suppress any further electron avalanches in the tube until another nuclear ray or particle enters the tube. The action of the quenching gas is complex and still not thoroughly understood.

An important consideration in operating the geiger tube is the electrical potential maintained across the two electrodes. With the potential at zero, no current pulses

flow into the external counting circuit although ions and electrons are being formed by nuclear radiation entering the tube. When a small voltage is applied, pulses of current of very small amplitude begin to flow in the external circuit as some of the electrons are attracted to the anode. Most of the freed electrons, however, recombine with ions. As the voltage is progressively increased, a point is reached where each ionization, no matter how small, will produce an electron avalanche which quickly spreads throughout the tube. The voltage level at which this avalanche occurs is called the geiger threshold. It marks the beginning of a voltage range known as the geiger region. In this region, at low radiation intensities, all pulses are of equal height. Further, the number of pulses resulting from a given intensity of radiation remains essentially constant as the high voltage is increased. This is known as the geiger plateau. The geiger plateau is illustrated in Figure 3, which depicts a typical performance curve of a halogen-quenched geiger tube. As shown, the geiger threshold (V_t) begins at approximately 820 volts. As the voltage is increased to 860 volts, a sharp rise in the number of output pulses occurs; however, from 860 volts to approximately 1000 volts (the geiger plateau), only a relatively small change occurs in the number of output pulses. If the voltage is increased beyond the plateau, the geiger tube goes into complete discharge. It fails to quench itself and continues to form large numbers of pulses even though there is no ionizing radiation. Operating the tube at this voltage level is valueless, of course, since there is no relationship between the number of output pulses and the amount of nuclear

radiation.

It might be concluded from the above that because the geiger tube is sensitive to ionizing rays or particles, it can be used to detect the presence of all ionizing types of radiation. This is not the case, however, because the geiger tube can only detect nuclear radiation which is capable of penetrating the wall of the geiger tube.

Different types of radiation have different penetrating powers based upon a property known as "specific ionization". Specific ionization is defined as the number of ions formed by an ionizing ray per centimeter of its path. If the specific ionization is very low, which is true of gamma rays and hard x-rays, then the radiation will penetrate relatively thick walls of dense materials (even two inches of lead). If the specific ionization is moderate, as is the case with many types of beta radiation, then considerably thinner and less dense materials (1/16" steel or 3/16" aluminum) will stop the radiation. Alpha rays, which have a very high specific ionization, are stopped by a very thin sheet of paper.

It can be seen, therefore, that if a geiger tube is to detect all three types of radiation, some portion of its wall must be thin enough to allow the penetration of alpha particles. The tube supplied with the Radioactivity Demonstrator has a thinned-out section of its wall that permits the penetration of hard beta radiation as well as gamma radiation. It cannot detect alpha or soft beta radiations because the tube wall prevents them from entering the tube.

The different penetrating abilities of the various types of radiation can be used to advantage when it is

Figure 3. TYPICAL OPERATING PLATFORM FOR A HALOGEN-QUENCHED GEIGER TUBE

- The curve was obtained under the following conditions:
- (1) Probe containing g-m tube placed in clip on calibrated mounting board, with probe shutter open.
 - (2) Reference source placed in central groove on calibrated mounting board at a distance of 4.75 inches from the probe, with the labelled surface of the source facing the probe.
 - (3) The voltage was increased in 20-volt steps, and the counting rate was recorded at each voltage point.

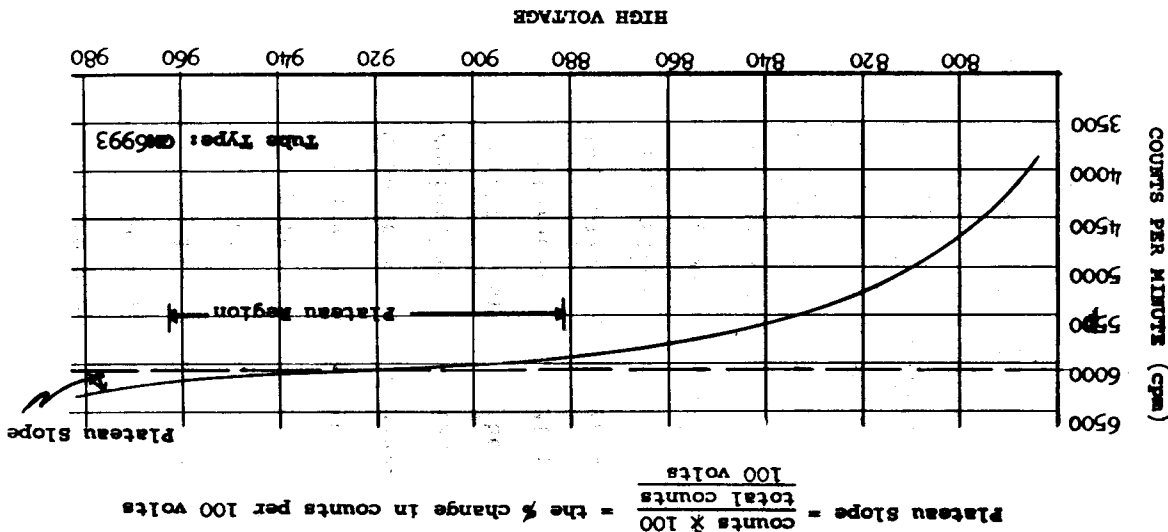

desirable to use a single tube for different applications as, for example, measuring beta radiation in the presence of gamma radiation and vice versa. This is accomplished by means of the Probe Assembly described below.

b. Probe and Cable Assembly

The Probe and Cable Assembly is shown as item 4 in Figure 1. As can be seen, the Probe section consists of a metal cylinder which is sealed at its forward end and which is open and internally threaded at its rear end. In addition, the probe is provided with a metal shield which can be rotated to expose the geiger tube inside the probe. In operation, a measurement is taken with the shield open, i.e., with the wall of the tube exposed. This measurement provides an indication of the combined beta and gamma radiation. A measurement is then taken of the gamma intensity alone by rotating the shield until it covers the tube, thereby preventing the beta particles from entering. By subtracting the gamma measurement from the total, the effect of the beta contribution may be obtained.

c. Radiological Demonstration Unit

The Radiological Demonstration Unit is shown as item 3 in Figure 1. This instrument accepts input pulses from the Geiger tube, and indicates the presence of radioactivity by means of a flashing neon bulb, a volume-controlled loudspeaker, and a large panel meter. The geiger probe and cable assembly are integrally connected to the instrument through the rear panel. The rear panel also contains a mounting clamp and brackets for securing the probe and cable assembly, brackets for the power cord, two fuse receptacles, and an external meter connector. As shown in Figure 4, the front panel of the

Demonstration Unit contains the following controls and indicators:

HIGH VOLTAGE ADJUSTMENT: Located in the upper left corner of the front panel, the HIGH VOLTAGE ADJUSTMENT knob is used to regulate the amount of high voltage being applied to the geiger tube. As this control knob is rotated clockwise, the voltage is increased.

PANEL METER: The panel meter, located at the top of the front panel, provides a dual reading of both the high voltage and the number of pulses or counts being received from the geiger tube. The scale of the meter is graduated from 0 to 1500 in major divisions of 100 each. Depending upon the mode of operation of the instrument, the reading on the meter scale indicates either the number of volts being applied to the geiger tube or the number of counts being received from the geiger tube.

SELECTOR KNOB: The selector knob, though not labeled as such, is located in the lower center portion of the front panel. This control is used to select the mode of operation for the instrument. Its four positions are OFF, HIGH VOLTAGE CHECK, COUNTS PER MINUTE X10, and COUNTS PER MINUTE X1. The OFF position, de-energizes the instrument. In the HIGH VOLTAGE CHECK position, the panel meter is switched into the high voltage circuit so that the meter reads the amount of high voltage being applied to the geiger tube; in the COUNTS PER MINUTE X10 position, the panel meter is switched into the ratemeter circuit such that the meter reading multiplied by 10 represents the number of counts being received from the geiger tube (this position is also referred to as the 15,000 CPM range of the instrument); the COUNTS PER MINUTE X1 position performs the same function as the preceding setting except that it places the meter in the 1500 CPM range, i.e., the meter reading corresponds to the number of counts being received.

LOUDSPEAKER LOUDNESS: Located in the upper right corner of the front panel, the LOUDSPEAKER LOUDNESS knob controls the volume of the speaker located within the instrument. The speaker emits a clicking sound each time a pulse is received from the geiger tube.

The rear panel of the Demonstration Unit, shown in

Figure 4, contains the following receptacles:

FUSE: The FUSE receptacle houses a one-ampere fuse. It is opened by depressing the fuse holder and rotating the holder in the direction indicated.

SPARE FUSE: One spare fuse is housed in this holder, which is opened in the same manner as described above. If the spare fuse is used, care should be taken to refill the holder with a replacement fuse as soon as possible.

EXTERNAL RECORDER: The EXTERNAL RECORDER receptacle will accommodate any standard 1-ma, 1500-ohm strip chart recorder equipped with a cable and an Amphenol type 91-MC3M plug. The toggle switch located below the receptacle connects the receptacle into the ratemeter circuit when the switch is placed in the ON position.

d. Calibrated Mounting Board

The Calibrated Mounting Board is shown as item 6 in Figure 1. As can be seen, the Calibrated Mounting Board is provided with a series of slots running crosswise on the board, a central groove running lengthwise, a scale calibrated in inches and centimeters, and a probe mounting clip. The purpose of the mounting board is to aid in demonstrating various properties of radioactivity, such as absorption and inverse square law, which are discussed in detail in Part II of this manual. The slots in the mounting board accommodate the various absorbers supplied with the equipment, the central groove accepts the radioactive source, and the mounting clip positions the probe assembly crosswise so that the center of the probe window falls at the center groove. The importance of the calibrations and the positioning features of the mounting board will become more apparent to the reader as Part II is covered. For the moment, suffice to say that the mounting board provides the means for creating the reproducible geometries required for many experiments in radioactivity.

e. Radium Beta-Gamma Sources

The Radium Beta-Gamma Sources are shown as item 7 in Figure 1. As their name implies, these sources provide the beta and gamma radiation which is required both for checking the operation of the geiger tube and the radioactivity demonstrator and for the various experiments described in Part II.

Figure 4 FRONT AND REAR PANEL VIEWS OF DEMONSTRATION UNIT

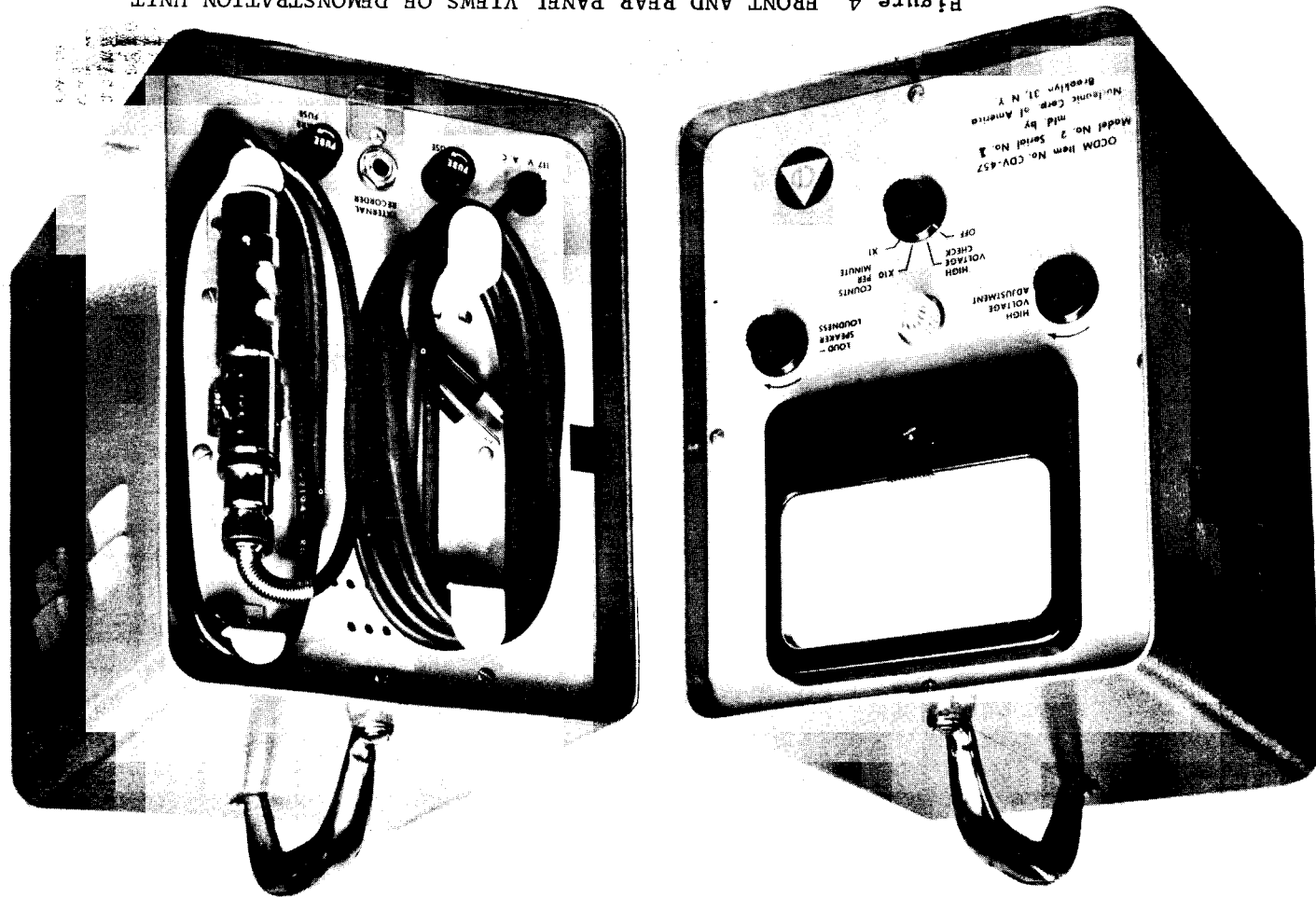

It should be noted that the optimum radiation of beta particles will be obtained from the face of the source that is printed white.

f. Flat and Cylindrical Absorbers

The flat absorbers are shown as items 8, 9 and 10 in Figure 1. Each absorber is 4 inches square by approximately 1/32-inch thick to fit in the slots of the Calibrated Mounting Board. Fourteen aluminum, twenty cardboard, and ten lead absorbers are provided for use in the experiments described in Part II. In addition, one cardboard, one lead, and one aluminum cylindrical absorber, two inches in diameter, six inches long by 1/32-inch thick are provided. These are shown as items 11, 12 and 13 in Figure 1. As with the flat absorbers, the cylinders are designed for use in the experiments described in Part II.

Section 3

THEORY OF OPERATION

Since the theory of operation of the geiger tube was discussed in Paragraph 4a of Section 2, this section will be devoted to a description of the electrical theory of operation of the Radiological Demonstration Unit.

1. Input Circuit

As shown in the schematic diagram of Figure 5, regulated positive high voltage is supplied to the geiger tube through a 1-megohm load resistor, R1. When the high voltage applied to the geiger tube has been properly set by means of the HIGH VOLTAGE ADJUSTMENT control, a pulse of current flows from the geiger tube through the load resistor for each ionizing ray or particle that enters the tube. The resulting

Figure 5 SCHEMATIC DIAGRAM OF DEMONSTRATION UNIT

WIRING COLOR CODE

APPLICATION	COLOR
GROUND	BLACK
FILAMENTS	BROWN
B+	RED
CONTROL GRID	GREEN
PLATE	BLUE
CATHODE	YELLOW
A.C.	BROWN TRACER
MISCELLANEOUS	PURPLE

NOTES

- 1) ALL RESISTOR VALUES ARE IN OHMS, 1/2W ±10%.
- 2) ALL CAPACITOR VALUES ARE IN MMFD 600V.
- 3) LAST "R" NUMBER IS 30.
- 4) ALL VOLTAGE TEST POINTS ARE MADE WITH A 20,000 OHM PER VOLT METER. THE "V" ADJ IS SET AT 850V. S-1 IS SET AT POSITION.
- 5) S2 IS SHOWN IN EXTERNAL RECORDER POSITION.

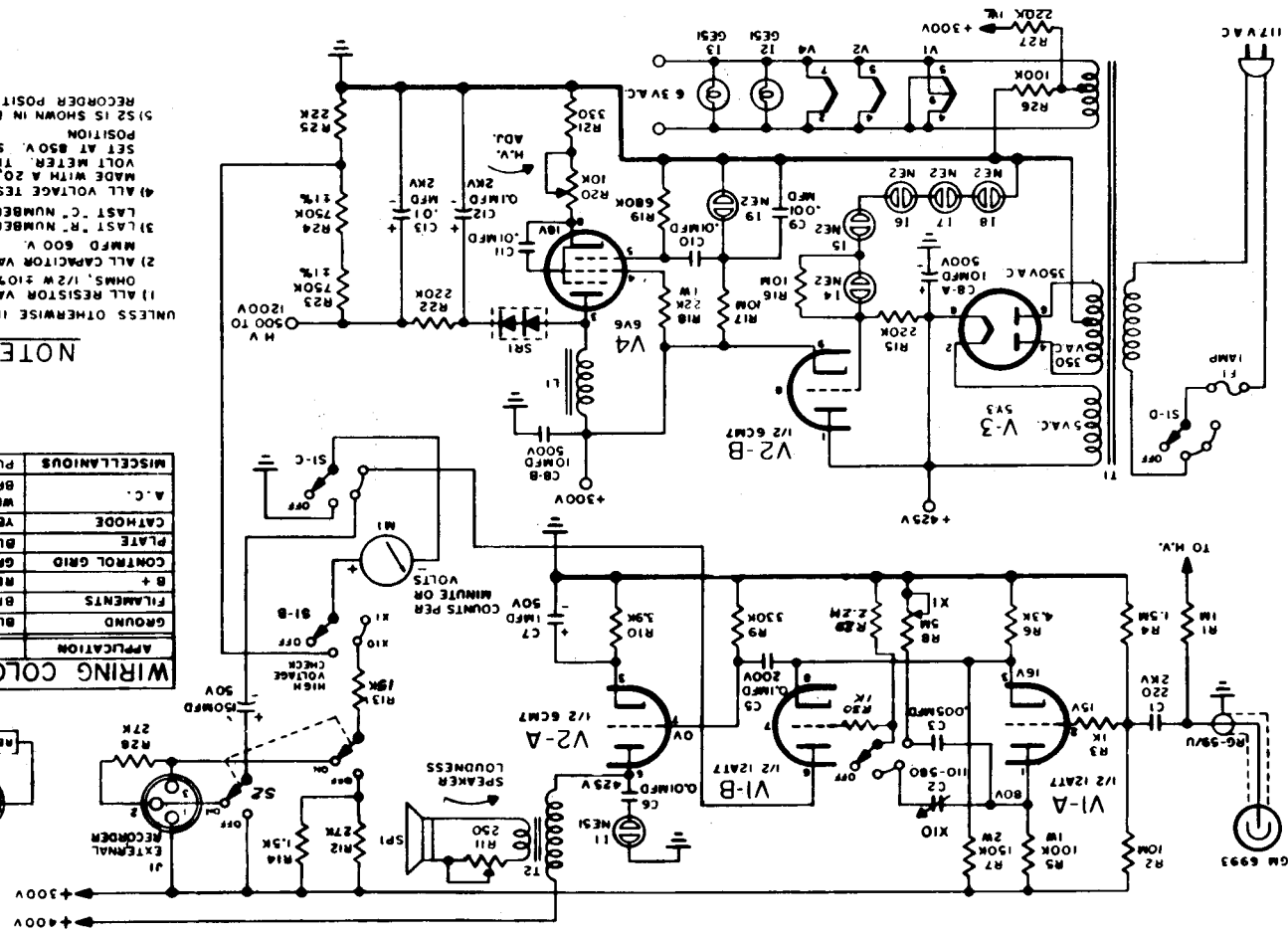

voltage drop across the load resistor produces a negative pulse of voltage at the grid of the univibrator VIA. VIA is normally conducting because of the positive potential being applied to its grid via voltage divider resistors R2 and R4. Conduction of VIA produces a voltage drop of approximately 16 volts at the cathodes of V1A and V1B. Since the grid of V1B is at ground potential, the 16-volt bias effectively maintains V1B at cut-off.

When the geiger tube is activated, the negative pulse developed across R1 is applied to the grid of V1A via coupling capacitor C1. Since V1A is normally conducting, the negative pulse causes a decrease in the plate current of V1A which, in turn, produces a positive pulse at the plate of V1A. This positive pulse is coupled to the V1B grid via capacitor C2 or C3, depending on the position of the selector switch, S1-A. (With S1-A in the X1 position, C3 is used; with S1-A in the X10 position C2 is used.) As the positive pulse exceeds the grid bias of V1B, V1B begins to conduct, thereby raising the potential across the common cathode resistor (R6) of V1A and V1B, thus driving V1A further negative to cut-off. As V1A becomes non-conducting, its plate voltage is raised to the supply potential (+ 300 V) and coupling capacitor C2 or C3, whichever is being used, is charged to this new potential. Each coupling capacitor comprises one portion of an RC network which controls the length of time that V1B will conduct. This time period is a function of the time required for C2 to become fully charged via the resistance of R29 or the time required for C3 to become fully charged via the resistance of R29 in parallel with the resistance setting of R8.

As C2 (or C3) discharges, the amplitude of the positive pulse at the grid of V1B becomes progressively smaller until the normal grid bias cuts off V1B. When V1B cuts off, the corresponding drop in the common cathode potential of V1A and V1B permits V1A to conduct again. Since the average time between successive pulses from the geiger tube is considerably longer than the duration of the conduction of V1B, the entire circuit reverts to its steady-state condition after each input pulse.

2. Rate-meter Circuit

The output of V1B is used to provide the reading of count rate, which appears on the front panel meter. This reading actually represents the average number of counts per unit time. In order to obtain this average reading, the output of V1B is integrated through an R-C network consisting of capacitor C4 and resistor R12. Each time V1B conducts an increment of charge is applied to capacitor C4. While the amplitudes of the pulses charging this capacitor are constant, the frequency at which they occur (or the frequency at which V1B conducts) is identical to the frequency of the pulses coming from the geiger tube. Since capacitor C4 is shunted by resistor R13 in series with the meter, the average current through the meter is thus a measure of the average rate at which incoming pulses trigger V1A-B. The average current in the meter for a given pulse rate can be varied by varying the length of the charging period per pulse in V1A-B. As described previously, the charging period is determined by the time constants associated with either the 0-1500 cpm range (X1 position of selector switch) or the 0-15,000 cpm range

(X10 position of the selector switch)

3. Audio Circuit

Aural and visual indications of radioactivity are derived from the output of V2A. This tube is self-biased very close to cut-off by cathode resistor R10. An input pulse from the common cathode of V1, coupled via C5 to the grid of V2A, effectively overcomes the grid bias and causes V2A to conduct. The output pulse from V2A is fed directly through transformer T2 to the speaker, and also via capacitor C6 to the neon bulb, I1.

4. Power Supply Circuit

The primary winding of transformer T1 receives 110v ac, 50-60 cps, via the contacts of switch S1. The secondary windings of T1 consist of a 5-volt a-c winding to power the filaments of V3; a 6.3-volt winding to power the filaments of V1, V2, V4, I2, and I3; and a 350-volt a-c winding from which the regulated B+ voltage is derived. The secondary winding is connected to V3, which functions as a full-wave rectifier and whose 425-volt output is filtered by capacitor C8A. This output voltage across C8A, however, is unregulated, and will tend to vary as the line voltage varies. Regulated voltage is achieved by employing the 425-volt output to ignite the series of neon glow tubes I4 through I8, thereby producing across the sum of these tubes a constant potential of 290 volts. This stable voltage is applied to the grid of V2B, which is used as a cathode follower. A cathode follower is essentially a unity gain amplifier. Thus, the cathode potential of V2B is very closely related to the grid potential, which in this case is being held constant by the stable

voltage produced across the neon tubes. The cathode output of V2B, (300 volts) regulated, is applied to a relaxation oscillator circuit consisting of R16, C9 and I9. The voltage across R16 (+300V) slowly charges capacitor C9 until a value equal to the striking voltage of I9 is reached. At this point, I9 conducts heavily and instantaneously discharges C9, whereupon C9 begins to charge again, repeating the cycle. The sawtooth voltage across C9 is coupled via C10 to the control grid of V4. During the positive portion of the sawtooth wave, the voltage applied to the control grid causes the plate current of V4 to build up gradually. The negative portion of the sawtooth voltage drives the control grid rapidly to cut-off. When the plate current of V4 increases during the slow rise of its grid voltage, energy is stored in the magnetic field of plate choke L1. As soon as the plate current of V4 is cut off by the sharp fall of its grid voltage, the magnetic field around L1 collapses and causes a damped oscillating voltage of approximately 2000 volts to exist on the plate of V4. This oscillating voltage is then rectified by half-wave rectifier SR1, and filtered by C12, R21, and C13 before being applied to the geiger tube. The amount of current change in V4 (and hence the amount of high voltage being generated) is controlled by varying the resistance between the cathode of V4 and ground by means of resistor R20, which is designated as the HIGH VOLTAGE ADJUSTMENT on the front panel of the instrument.

5. Chart Recorder Circuit

The recorder circuit in the Demonstration Unit is comprised of toggle switch S2, resistor R28, and recorder jack J1. The strip-chart recorder that is to be used with the Demonstration

Unit must be equipped with a cable and an Amphenol type 91-MC3M plug, which has been jumpered as shown in Figure 5. The toggle switch arrangement is so designed that the plate impedance of V1B is maintained under any mode of operation to insure a correct meter reading and to provide the necessary critical damping for the recorder.

With S1 in either the X1 or X10 position and S2 in the OFF position, the meter return to B+ follows the path through R13 and the parallel resistance network of R12 and R14. When a chart recorder is used, S2 is placed in the ON position, thereby bypassing the parallel resistance network of R12 and R13 and substituting R28 in parallel with the 1500-ohm impedance of the recorder.

Section 4 INSTALLATION

1. Unpacking the Equipment

As shown in Fig. 6A-B, the demonstration unit, accessories, instruction manuals, and radiological instruments are packed in the various labelled storage compartments of the shipping and storage case. The upper section of the storage case contains the radioactive sources, the spare g-m tube, dosimeters, and two instruction manuals; the lower section contains the demonstration instrument, food and water standards, training film containers, absorbers, cylinders, calibrated mounting board, and dosimeter chargers.

After removing the storage case from its cardboard shipping container, remove the padlock, release the two pull catches, and raise the lid of the storage case to expose the lower section. Remove the demonstration unit and the mounting board

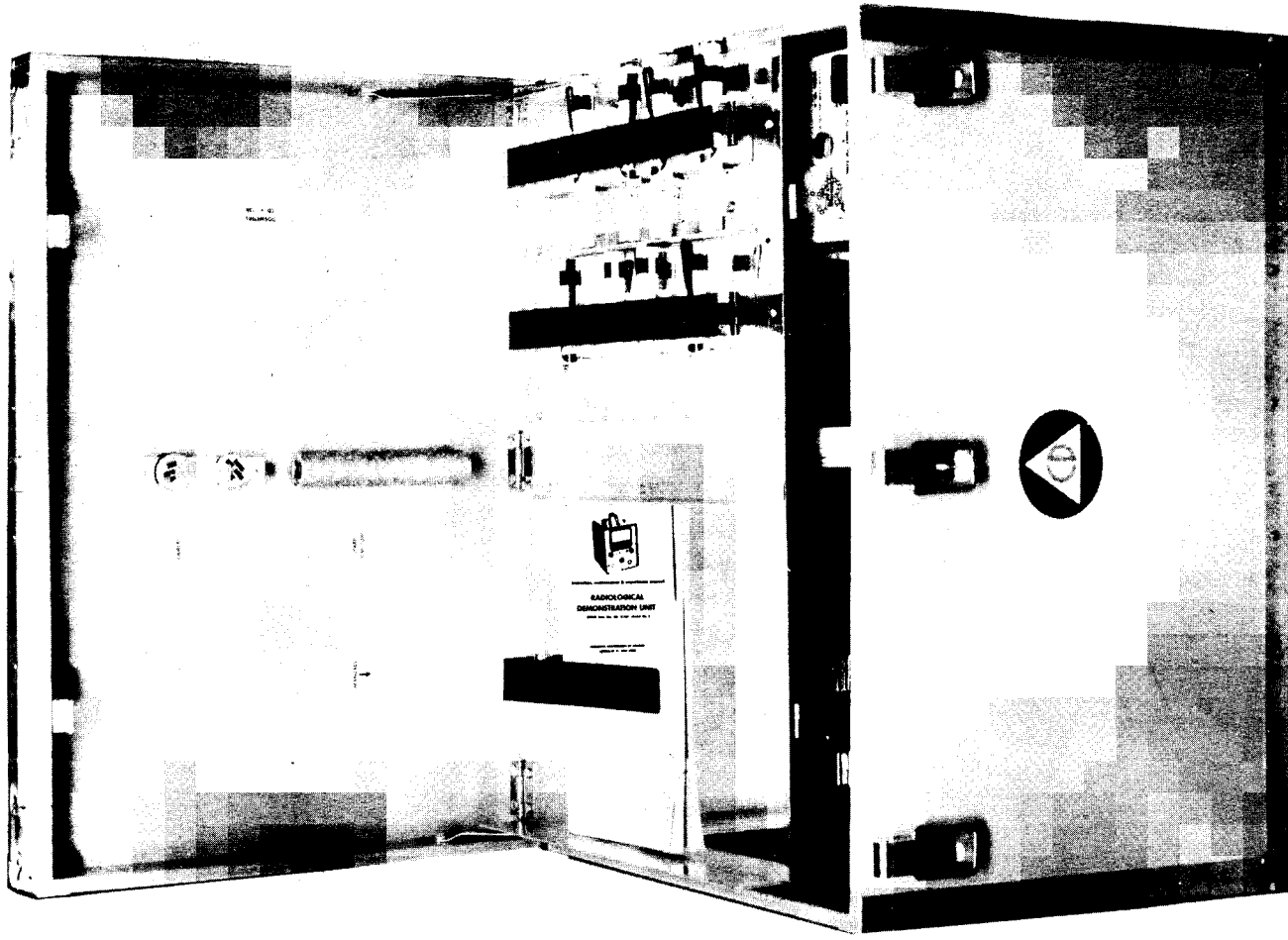

Figure 6A SHIPPING AND STORAGE CASE, INNER LID OPEN

from their compartments, release the two pull catches of the inner lid to expose the upper compartment, and remove one radioactive source. Next, follow the procedure below to place the instrument into its proper operating condition.

2. Operating the Demonstration Unit

- Step 1: Unwind the power cord and the geiger probe and tube from their respective storage brackets at the rear of the instrument.
- Step 2: Open the rotating shield of the geiger probe and place the probe in the mounting clip of the calibration board. Locate the radioactive source in the central groove of the mounting board at a distance of 12 inches from the probe.
- Make certain that the white source face marked "Radium Beta-Gamma Source" is facing the probe.
- Step 3: With the selector knob in the OFF position, plug the power cord into any 110-v a-c outlet.
- Step 4: Rotate the HIGH VOLTAGE ADJUSTMENT control fully counter-clockwise.
- Step 5: Place the EXTERNAL RECORDER toggle switch in the OFF position.
- Step 6: Turn the selector knob to the HIGH VOLTAGE CHECK position.
- Step 7: Allow the instrument to warm-up for a period of at least one minute.
- Step 8: Rotate the LOUDSPEAKER LOUDNESS control fully clockwise.
- Step 9: Slowly rotate the HIGH VOLTAGE ADJUSTMENT control clockwise until clicks just begin to be heard from the loudspeaker. Note the voltage reading indicated on the panel meter. This reading represents the starting voltage of the geiger tube (V_s), approximately 820 volts.
- Step 10: Raise the high voltage to 80 volts above the V_s (to approximately 900 volts) by slowly rotating the HIGH VOLTAGE ADJUSTMENT control clockwise. This is the operating voltage (V_o) of the geiger tube.
- Step 11: Rotate the selector knob to the X1 position and observe the reading on the panel meter. This reading should be approximately 800 to 1200

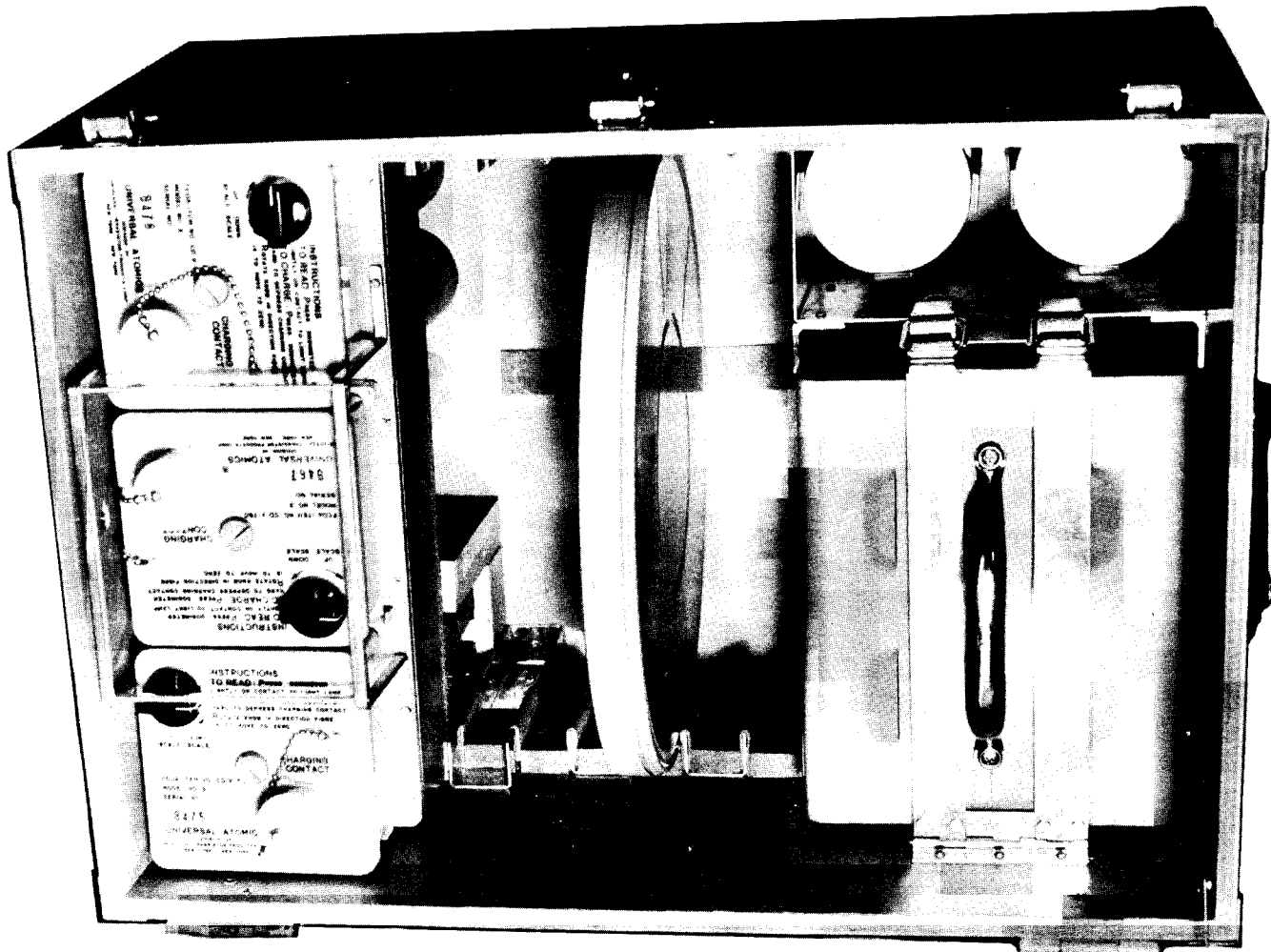

Figure 6B SHIPPING AND STORAGE CASE, INNER LID CLOSED

counts per minute.

Step 12: To turn the instrument off, rotate the HIGH VOLTAGE ADJUSTMENT control fully counter-clockwise and place the selector knob in the OFF position.

Section 5

OPERATION

Before using the instrument to measure radioactivity, make certain that the proper operating voltage is being applied to the geiger tube by repeating Steps 2 through 10 as described above.

1. Using The Instrument For General Survey

- Step 1: Connect an extension cord (15 feet or longer) to the power cord of the instrument.
- Step 2: Place the instrument in operation as described in Section 4.
- Step 3: Turn the LOUDSPEAKER LOUDNESS control fully clockwise.
- Step 4: Place the selector knob in the X10 position.

Step 5: With the geiger probe in hand, slowly move about the area to be surveyed, listening for clicks from the loudspeaker. As the radioactive object or area is approached, the frequency of loudspeaker clicks will increase. Continue moving in this direction until the point of maximum radiation intensity is found.

Step 6: To determine the intensity of radiation in counts per minute, refer to the reading on the panel meter.

Step 7: Multiply the meter reading by 10 to obtain the actual number of counts/minute (since the selector knob was placed in the X10 position in step 3). If the reading on the meter is less than 1500, switch to a lower scale by placing the selector knob in the X1 position.

2. Measuring Beta and Gamma Radiation

- Step 1: Slide the rotating shield of the geiger probe to the open position.

Step 2: Take a meter reading as described above. This reading is the sum of beta and gamma radiation.

Step 3: Close the rotating shield of the geiger probe and take another meter reading. This reading represents the gamma radiation only.

Step 4: Subtract the second reading from the first to obtain the amount of beta radiation.

3. Connecting a Strip-Chart Recorder

- Step 1: Connect a cable and an Amphenol type 91-MC3M type plug to the recorder.
- Step 2: Connect a jumper wire between pins 1 and 2 of the Amphenol plug. (Refer to the diagram in the Figure 5.)
- Step 3: Insert the recorder plug into the EXTERNAL REORDER receptacle located at the rear panel of the Demonstration Unit.
- Step 4: Place the EXTERNAL RECORDER toggle switch in the ON position.
- Step 5: Place the Demonstration Unit into operation as described in Section 4.

Section 6

OPERATOR'S MAINTENANCE

In the event that instrument malfunction is encountered, the operator may attempt to restore satisfactory operation of the instrument by replacing the fuse and/or the geiger tube. This form of maintenance, however, should only be undertaken if the following symptoms are evident:

- (1) If the panel meter does not light up after the selector knob has been placed in any position, inspect the fuse, and replace if it is burned out.
- (2) If no reading of count rate appears on the panel meter even though the proper operating voltage is being applied to the geiger tube and a radioactive source is placed next to the geiger tube. (Replace the geiger tube).

CAUTION

DISCONNECT THE POWER CORD BEFORE ATTEMPTING TO REPLACE THE FUSE OR THE GEIGER TUBE

1. Replacing the Fuse

The fuse receptacle is located on the rear panel of the

instrument. To open the receptacle, depress the receptacle knob and rotate it counter-clockwise. Remove the fuse and examine it to determine whether the metal element is broken. If the fuse is defective, replace it with the fuse located in the SPARE FUSE receptacle.

If replacing the fuse does not restore satisfactory operation of the instrument, the instrument may require corrective maintenance.

2. Replacing the Geiger Tube

Remove the geiger tube from the probe housing by unscrewing the probe housing from its associated connector. Grasp the geiger tube by the base and gently withdraw it from the probe housing. Reverse the above procedure to replace the geiger tube with the spare tube located in the upper section of the shipping and storage case. Here again, if replacing the geiger tube does not restore satisfactory operation of the instrument, the instrument should be serviced by a trained repairman.

Section 7

PREVENTIVE MAINTENANCE

Preventive maintenance of the equipment should be performed periodically to keep it in good working order. The instrument and associated accessories should always be kept in the shipping and storage case to prevent the accumulation of dirt and moisture. The exterior surfaces of the instrument and probe should be wiped with a clean dry cloth if any dirt or dust accumulates. The front and rear panel screws and the control knobs should be checked occasionally for tightness with a screwdriver, but should not be tightened excessively.

The case, front panel, and carrying handle of the instrument should be inspected for evidence of rust and corrosion. At the same time, the instrument should be checked for normal operation as described in Section 4, and the probe and power cables should be inspected for cuts, breaks, fraying, kinks and deterioration.

Section 8

CORRECTIVE MAINTENANCE

WARNING

HIGH VOLTAGES EXIST IN THE INSTRUMENT AND IN THE GEIGER TUBE CIRCUIT. DISCONNECT THE POWER CORD BEFORE UNDERTAKING MAINTENANCE.

1. General

This section contains general information to aid personnel in trouble shooting and repair of the Radiological Demonstration Instrument. For proper servicing, a 20,000 ohm/ volt multimeter and an electron tube tester will be required.

2. Preliminary Checks

By careful visual and mechanical inspection, troubles may often be easily located before any electrical measurements are required. To perform visual inspection of the instrument interior, remove the instrument from its case by unscrewing the four screws located at the top, bottom, and sides of the front panel and the two screws located at the top and bottom of the rear panel. Slide the instrument forward until it is out of the case.

- (a) Check for swelling or leaky capacitors.
- (b) Check that all tubes are properly seated in their sockets.
- (c) Check both the power and geiger probe cables for breaks.

- (d) Check for frayed or damaged wiring.
- (e) Check for possible shorts due to physical movement of parts.

3. Localization of Faults

As was described previously, the instrument is comprised of an input circuit, a power supply circuit, a ratemeter circuit, and an audio circuit. Careful consideration of trouble symptoms will usually make it possible to localize the trouble to one or more of these circuit groups. For example, if the panel meter is indicating the correct radiation reading and no clicks can be heard from the loudspeaker, the fault must lie in the audio circuit. Check tube V2A, transformer T2, and potentiometer R11. If the reverse situation occurs, i.e., clicks can be heard from the loudspeaker and the meter is inoperative, check capacitor C4, resistors R12 and R13, Jack J1, switch S1B, and meter M1. In most cases of malfunction, the fault will be due to a defective vacuum tube. It is recommended, therefore, that the vacuum tubes in the affected circuit be checked first before undertaking voltage or resistance measurements. Commonly encountered trouble symptoms and probable location of faults are listed in Table II. Intermittent defects, partial shorts, and similar ambiguous faults which cannot be recognized as due to a defective tube can be localized by taking voltage and resistance measurements as indicated in Table III. Refer to Figures 7A and 7B to establish the physical location of the instrument components. (Resistor R10 is located immediately below the recorder toggle switch and, therefore, cannot be seen in Figure 7B.)

4. Calibration Procedure

Each time an electronic component in the instrument is

replaced, the instrument should be calibrated in each of its operating ranges. To perform the calibration, a signal generator having a 1.0-volt negative pulse with a rise time of 0.25 microsecond will be required.

- Step 1: Remove the instrument chassis from its case as described in Paragraph 2 of Section 8.
- Step 2: Remove the geiger tube and probe from the probe-cable assembly as described in Paragraph 2 of Section 6.
- Step 3: Connect a signal generator to the geiger tube socket with a 0.001-mfd capacitor rated at 2500 volts connected in series.
- Step 4: Connect the power cord to a 110-volt a-c line.
- Step 5: Rotate the selector knob to the X1 position.
- Step 6: Set the signal generator to produce a signal having a frequency of 20 cps. This corresponds to a meter reading of 1200 cpm.
- Step 7: Observe the reading on the panel meter and rotate the X1 screw shown in Figure 7A until the panel meter indicates 1200 cpm.
- Step 8: Rotate the selector knob to the X10 position.
- Step 9: Set the signal generator to produce a signal having a frequency of 200 cps (12,000 cpm)
- Step 10: Observe the reading on the panel meter and adjust the X10 screw shown in Figure 7A until the panel meter indicates 12,000 cpm.

Table II

TROUBLE-SHOOTING CHART

1. No high voltage indication on panel meter with selector knob in HV CHECK position.
 - (1) Check V2, V3.
 - (2) Check for low voltage at pin 9 of V2B.
 - (3) Check V4.
 - (4) Check R16, R17, R19, R20, R21, R22, R23, C9, C10, C11, C12, C13, I9, SR1, L1, M1.
 - (5) Check S1.
2. With radioactive source near geiger tube and high voltage present, no indication of radiation intensity on meter or from speaker.
 - (1) Check g-m tube.
 - (2) Check V1.
 - (3) Check contact of S1.
 - (4) Check M1.
 - (5) Check R1, R2, R3, R4, R5, R6, R7, R8, R12, R13, J1, M1, S1, R29, C2, C3.
3. Constant meter reading on all ranges, independent of radiation intensity.
 - (1) Check cathode resistance to ground of V1.
 - (2) Check for resistance leakage between pin 1 and 7 of V1.
 - (3) Check C2 and C3.
4. Same symptom as 3 above, on one range only.
 - (1) Check capacitor for that range.
 - (2) Check switch contacts.
5. Meter reading erratic or abnormally high when tested with radioactive source.
 - (1) Check V1, V2.
 - (2) Check R12, R13, C4.
 - (3) Check for intermittent switch S1 contacts.
 - (4) Check for intermittent at J1.
 - (5) Check R14, R15, I4 through I8.
6. Meter face not illuminated, though instrument functions properly.
 - (1) Check I2, I3.

Table III

VOLTAGE AND RESISTANCE MEASUREMENTS

PIN NO.	V1	V2	V3	V4
1	80V 220K	425V		
2	15V		425V	100V
3	16V 4.5k	21V 3.9k		300V 110k
4	100V 80k	100V 80k	350vac 220ohms	225V 130k
5	100V 80k	100V 80k	gnd	0v 800k
6	300V 500k	425V	350vac 220ohms	
7	0v 2m	0v 330k		100v 80k
8	16v 4.5k	290V	425V	18v 800 ohms
9	100v 80k	300v 110k		

All measurements taken with switch S1 in HIGH VOLTAGE CHECK position.

All measurements taken with 20,000 ohms/volt meter.

X1 CALIBRATION ADJ.

C8A-B

V1A-B

X10 CALIBRATION ADJ.

31

C12

SR1

V4

V3

V2A-B

Figure 7A TOP VIEW OF DEMONSTRATION UNIT CHASSIS

32

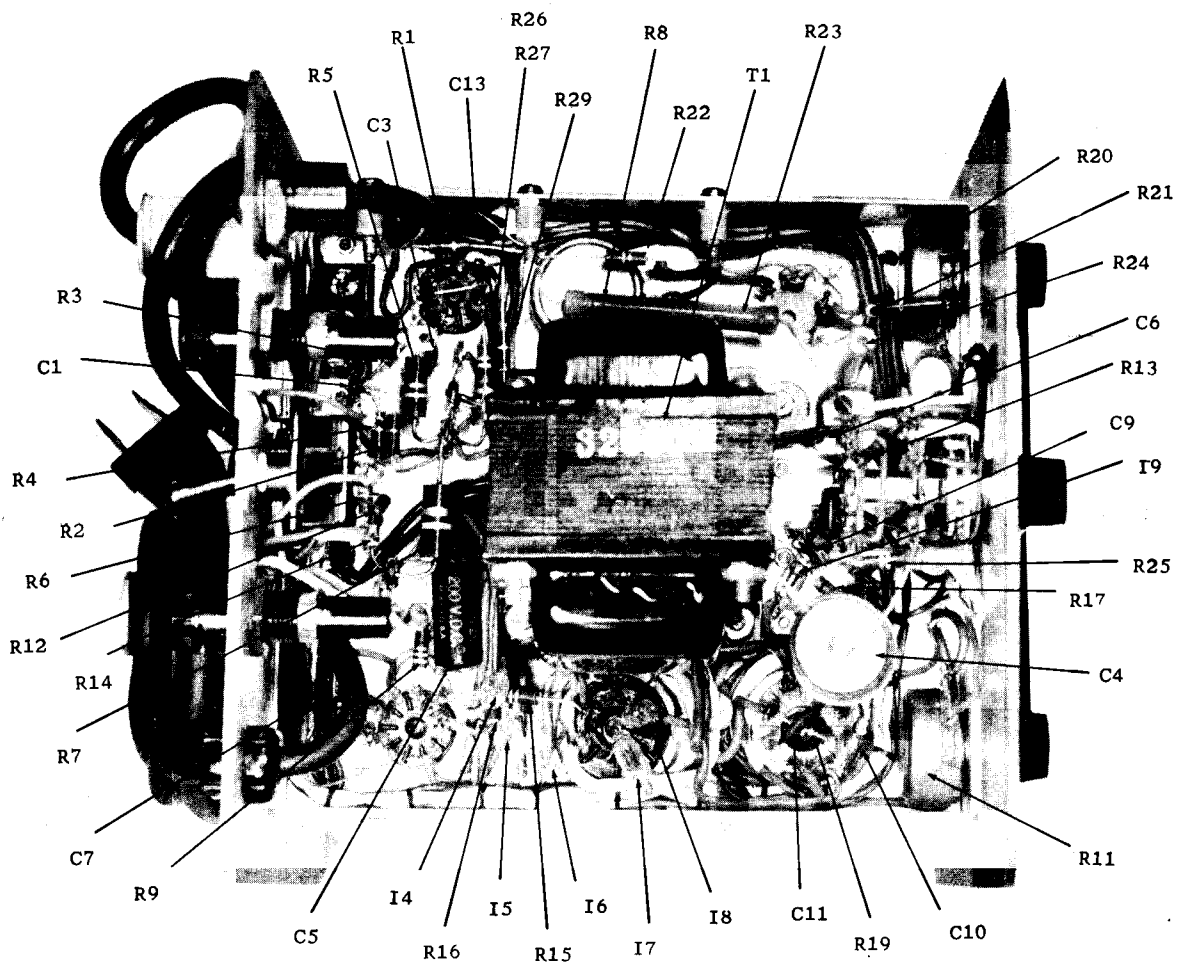

Figure 7B BOTTOM VIEW OF DEMONSTRATION UNIT CHASSIS

Section 9

PARTS LIST

<u>SYMBOL</u>	<u>DESCRIPTION</u>	<u>SPECIFICATIONS</u>	<u>MANUFACTURER</u>	<u>MFGR PART NO.</u>	<u>NUCLEONIC STOCK NO.</u>
C1	Couples GM6993 to V1A grid	Capacitor, fixed, ceramic dielectric, 220 mmfd, 2KV, <u>+20%</u> , disc	Erie Resistor Richfield, N.J.	838	RDA 25
C2	Couples V1A plate to V1B grid with S1 in X10 Pos.	Capacitor, variable, mica dielectric, 110-580 mmfd, 350V, <u>+20%</u>	Arco Electronics New York, N.Y.	4-67	RDA 26
C3	Couples V1A plate to V1B grid with S1 in X1 Pos.	Capacitor, fixed, paper dielectric, 0.005 mmfd, 500V, <u>+20%</u> ,	Sangamo	Type 811	RDA 27
C4	Pulse integrator capacitor	Capacitor, fixed, electrolytic, 150mfd, 50V, <u>+20%</u>	Aerovox Corp. No. Adams, Mass.	Type PRS	RDA 28
C5	Couples V1 cathode to V2 grid	Capacitor, fixed, ceramic dielectric, 0.1 mfd, 200V, <u>+20%</u> , disc	Cornell-Dubilier Corporation So. Plainfield, N.J.	2-P1	RDA 29
C6	D-C blocking capacitor for I1	Capacitor, fixed, ceramic dielectric, 0.01 mfd, 500V, <u>+20%</u> , disc	Erie Resistor Richfield, N.J.	Type 811	RDA 30

33

Section 9

PARTS LIST

<u>SYMBOL</u>	<u>DESCRIPTION</u>	<u>SPECIFICATIONS</u>	<u>MANUFACTURER</u>	<u>MFGR PART NO.</u>	<u>NUCLEONIC STOCK NO.</u>
C7	V2A cathode bypass	Capacitor, fixed, ceramic dielectric, 0.01 mfd, 500V, <u>+20%</u> , disc	Same as C5	BER 1	RDA 31
C8A	425-volt filter	Capacitor, fixed, electrolytic, 10/10 mfd,	Same as C5	Type UP	RDA 32
C8B	+300-volt filter	500V, <u>+20%</u>			
C9	Charging capacitor across I9	Capacitor, fixed, ceramic dielectric, 0.001 mfd, 400V, <u>+20%</u> , disc	Same as C1	831	RDA 33
C10	Couples saw-tooth voltage to V4 grid	Same as C6	Same as C6	Type 811	RDA 30
C11	V4 screen bypass	Same as C6	Same as C6	Type 811	RDA 30
C12	High voltage filter	Capacitor, fixed, paper dielectric, 0.1 mfd, 2KV, <u>+20%</u> , tubular	Goodall Electric Ogallala, Nebr.	522M	RDA 34
C13	High voltage filter	Capacitor, fixed, ceramic dielectric, 0.01 mfd, 2KV, <u>+20%</u> , disc.	Same as C1	3878	RDA 35

34

Section 9

PARTS LIST

<u>SYMBOL</u>	<u>DESCRIPTION</u>	<u>SPECIFICATIONS</u>	<u>MANUFACTURER</u>	<u>MFGR PART NO.</u>	<u>NUCLEONIC STOCK NO.</u>
FI	Fuses 110 VAC line	Fuse, 1 ampere, glass tube, 1/4" dia, 1 1/4" long	Bussman Mfg. Div. St. Louis, Mo.	AGC-1A	RDA 53
GM 6993	Detects the presence of beta-gamma radiation	Geiger-Muller tube halogen self-quenching, thin wall, max, vdc 920V, min vdc 860V	Anton Electronic Brooklyn 37, N.Y.	OCDM 6993	RDU-1B
35 I1	Provides visual indication of radiation intensity	Lamp, neon glow, miniature bayonet, 105-115V, 0.04W	General Electric Schenectady, N.Y.	NE51	RDA 41
I2-3	Illuminates panel meter	Lamp, neon glow, bayonet, 6.3V	Same as I1	GE 51	RDA 42
I4-9	Part of regulated 290-volt supply	Lamp, neon glow, miniature, pigtail leads	Same as I1	NE 2	RDA 43
L1	V4 plate load inductor	Transformer, filter reactor, 62 henries, 10 ma, 3200 ohms	Freed Transformer Brooklyn, N.Y.	32692	RDA 46

Section 9

PARTS LIST

<u>SYMBOL</u>	<u>DESCRIPTION</u>	<u>SPECIFICATIONS</u>	<u>MANUFACTURER</u>	<u>MFGR PART NO.</u>	<u>NUCLEONIC STOCK NO.</u>
M1	Provides indication of high voltage and counts per minute	Meter, illuminated, rated at 0-1 ma, accuracy +20% of full scale, resistance 100 ohms +5%	Ideal Precision Meter Brooklyn, N.Y.	460B	RDA 39
R1	GM6993 load resistor	Resistor, fixed, composition, 1M, 1/2W, +10%	Allen Bradley Milwaukee, Wisc.	Type EB	RDA 12
R2	V1A grid voltage divider	Resistor, fixed, composition, 10M, 1/2W, +10%	Same as R1	Type EB	RDA 6
R3	Parasitic suppressor	Resistor, fixed, composition, 1K, 1/2W, +10%	Same as R1	Type EB	RDA 7
R4	V1A grid voltage divider	Resistor, fixed, composition, 1.5M, 1/2W, +10%	Same as R1	Type EB	RDA 8
R5	V1A plate load resistor	Resistor, fixed, composition, 100K, 1W, +10%	Same as R1	Type GB	RDA 5
R6	V1A-B common cathode resistor	Resistor, fixed, composition, 4.3K, 1/2W, +10%	Same as R1	Type EB	RDA 2

Section 9

PARTS LIST

<u>SYMBOL</u>	<u>DESCRIPTION</u>	<u>SPECIFICATIONS</u>	<u>MANUFACTURER</u>	<u>MFGR PART NO.</u>	<u>NUCLEONIC STOCK NO.</u>
R7	V1A-B cathode bleeder	Resistor, fixed, composition, 150K, 2W, $\pm 10\%$	Same as R1	Type HB-	RDA 11
R8	V1B grid resistor	Potentiometer, variable, 5M, $\pm 20\%$	Same as R1	JA 1G024 S505 MA	RDA 14
R9	V2A grid resistor	Resistor fixed, composition, 330K, $\frac{1}{2}W$, $\pm 10\%$	Same as R1	Type EB	RDA 4
37 R10	V2A cathode resistor	Resistor, fixed, composition, 3.9K, $\frac{1}{2}W$, $\pm 10\%$	Same as R1	Type EB	RDA 5
R11	Speaker volume control	Potentiometer, variable, 250 ohms, $\pm 20\%$	Same as R1	JA 1G040 P103TA	RDA 23
R12	V1B plate load resistor	Resistor, fixed, composition, 27K, $\frac{1}{2}W$, $\pm 10\%$	Same as R1	Type EB	RDA 8
R13	Shunt resistor for J1	Resistor, fixed, composition, 15K, $\frac{1}{2}W$, $\pm 10\%$	Same as R1	Type EB	RDA 8a

Section 9

PARTS LIST

<u>SYMBOL</u>	<u>DESCRIPTION</u>	<u>SPECIFICATIONS</u>	<u>MANUFACTURER</u>	<u>MFGR PART NO.</u>	<u>NUCLEONIC STOCK NO.</u>
R14	V1B plate load resistor	Resistor, fixed, composition, 1.5K, $\frac{1}{2}W$, $\pm 5\%$	Same as R1	Type EB	RDA 1
R15	V2B grid resistor	Resistor, fixed, composition, 100K, $\frac{1}{2}W$, $\pm 10\%$	Same as R1	Type EB	RDA 9
R16	V2B grid resistor	Same as R2	Same as R1	Type EB	RDA 14
R17	I9 charging current resistor	Same as R2	Same as R1	Type EB	RDA 14
R18	V4 screen resistor	Resistor, fixed, composition, 22K, 1W, $\pm 10\%$	Same as R1	Type GB	RDA 18
R19	V4 grid resistor	Resistor, fixed, composition, 680K, $\frac{1}{2}W$, $\pm 5\%$	Same as R1	Type EB	RDA 2
R20	High voltage adjustment control	Potentiometer, variable, reverse logtaper, 10K, $\pm 20\%$	Same as R1	JA 1G040 PS2 1MA	RDA 24
R21	V4 cathode bias	Resistor, fixed, composition, 330 ohms, $\frac{1}{2}W$, $\pm 10\%$	Same as R1	Type EB	RDA 3

Section 9

PARTS LIST

<u>SYMBOL</u>	<u>DESCRIPTION</u>	<u>SPECIFICATIONS</u>	<u>MANUFACTURER</u>	<u>MFGR PART NO.</u>	<u>NUCLEONIC STOCK NO.</u>
R22	High voltage filter	Resistor, fixed, composition, 220K, $\frac{1}{2}$ W, <u>+10%</u>	Same as R1	Type EB	RDA 10
R23	Meter multiplier	Resistor, fixed, composition, 750K, 2W, <u>+1%</u>	Same as R1	Type HB	RDA 21
R24	Meter multiplier	Same as R23	Same as R1	Type HB	RDA 21
R25	Meter Shunt	Resistor, fixed, composition, 22K, $\frac{1}{2}$ W, <u>+10%</u>	Same as R1	Type EB	RDA 7
R26	Filament bleeder	Resistor, fixed, composition, 100K, $\frac{1}{2}$ W, <u>+10%</u>	Same as R1	Type EB	RDA9
R27	Filament bleeder	Resistor, fixed, composition, 220K, 1W, <u>+10%</u>	Same as R1	Type GB	RDA 19
R28	Shunt resistor for P1	Same as R12	Same as R1	Type EB	RDA 8
R29	Part of r-c network with C2 or C3	Resistor, fixed, composition, 2.2 M, $\frac{1}{2}$ W, <u>+10%</u>	Same as R1	Type EB	RDA 38

39

Section 9

PARTS LIST

<u>SYMBOL</u>	<u>DESCRIPTION</u>	<u>SPECIFICATIONS</u>	<u>MANUFACTURER</u>	<u>MFGR PART NO.</u>	<u>NUCLEONIC STOCK NO.</u>
N/A	High voltage and signal cable between g-m tube and instrument	Cable Assembly, includes RDC8 through 15	Nucleonic Corp. of America Brooklyn, N.Y.	Dwg # GSA-001	RDU-1CC
S1	Selector switch for off, high voltage, and range positions	Switch, rotary, 4-pole, 4-position, non-short- ing	Same as R1	Type GB	RDA 19
S2	Recorder output switch	Switch, toggle, 2 pole- 2 Position	Carling Electric Incorporated West Hartford, Conn.	AA252- BL	RDA 36
SP1	Provides aural indication of radiation intensity	Speaker, permanent magnet, 4-inch	Becker Electronics Valley Stream, L.I.	Type PM	RDA 52
SR#1	High voltage rectifier	Rectifier, Selenium	Int. Rectifier Co. Los Angeles, Calif.	61-1505	RDA 51
T1	Power supply transformer	Transformer, power, primary 1.5V 60cps, secondary 700V, 50ma, 5V, 2A, 6.3V, 2.5A	Freed Transformer Brooklyn, N.Y.	32690	RDA 44

40

Section 9

PARTS LIST

<u>SYMBOL</u>	<u>DESCRIPTION</u>	<u>SPECIFICATIONS</u>	<u>MANUFACTURER</u>	<u>MFGR PART NO.</u>	<u>NUCLEONIC STOCK NO.</u>
T2	Speaker trans- former	Transformer, primary impedance 7000 ohms, secondary impedance 4 ohms	Freed Transformer Brooklyn, N.Y.	32691	RDA 45
V1A V1B	Univibrator	Electron tube, twin tri- ode, glass envelope	Amperex Electronic Hicksville, L.I.	12AT7	RDA 47
V2A V2B	Audio amplifier Cathode follow-	Electron tube, dual tri- ode, glass envelope	Tungsol Electric Newark, N.J.	6CM7	RDA 48
V3	Rectifies 350- VAC from T1 secondary	Electron tube, full-wave rectifier, glass enve- lope	Tungsol Electric Newark, N.J.	5Y3	RDA 49
V4	High voltage amplifier	Electron tube, beam po- wer pentode, glass en- velope	Same as V2A	6V6GT	RDA 50
N/A	Connects 110-V AC power to instrument	Cable, line, type 18/2, over-all length 10.5ft., with #26 male plug	Cornish Wire Co. Williamstown, N.H.	CP, 18/ 2	RDA 55

41

Section 9

PARTS LIST

<u>SYMBOL</u>	<u>DESCRIPTION</u>	<u>SPECIFICATIONS</u>	<u>MANUFACTURER</u>	<u>MFGR PART NO.</u>	<u>NUCLEONIC STOCK NO.</u>
N/A	Instrument chassis	Chassis, 8.0625"x8.8125", cold rolled steel, in- cludes RDA2, RDA3	Same as RDA 80	Dwg # GSA- 008	RDA100
N/A	Tube cable mounting brack- ets, 1pr.	Bracket, aluminum	Same as RDA 80	Dwg # GSA- 010	RDA106
N/A	Line cord mount- ing brackets, 1 pr.	Bracket, aluminum	Same as RDA 80	Dwg # GSA- 010	RDA106
N/A	Instrument cabi- net	Case, 10.625"x15.875", cold rolled steel, in- cludes RDA108, RDA109, RDA110, RDA111	Same as RDA 80	Dwg # GSA- 011	RDA107
N/A	Front panel of instrument	Panel, Front, Aluminum	Same as RDA 80	Dwg # GSA- 012	RDA103
N/A	Instrument carrying handle	Handle	Same as RDA 80	Dwg # GSA- 013	RDA 94

42

Section 9

PARTS LIST

<u>SYMBOL</u>	<u>DESCRIPTION</u>	<u>SPECIFICATIONS</u>	<u>MANUFACTURER</u>	<u>MFGR PART NO.</u>	<u>NUCLEONIC STOCK NO.</u>
N/A	Socket for V1, V2	Socket, tube, 9-pin, top mounting	Elco Sales Co. Philadelphia, Pa.	196	RDA 56
N/A	Socket for V3	Socket, tube, octal, bot- tom mounting	Elco Sales Co.	600	RDA 58
N/A	Socket for V4	Socket, tube, octal, bot- tom mounting, mica, fill- ed	Elco Sales Co. Philadelphia, Pa.	608	RDA 57
N/A	Terminal	Terminal, stand-off	U.S. Eng. Corp. Los Angeles, Calif.	1417	RDA 79
43 N/A	Terminal	Terminal, stand-off	Nucleonic Corp. of America Brooklyn, N.Y.	RDA80	RDA 80
N/A	Mounting board for L1	Plate, mounting, choke phenolic	Same as RDA 80	Dwg # GSA- 003	RDA 88
N/A	Mounting board for C2	Plate, mounting, trimmer, phenolic	Same as RDA 80	Dwg # GSA- 004	RDA 78
N/A	Rear panel of instrument	Panel, rear, aluminum	Same as RDA 80	Dwg # GSA- 005	RDA104

Section 9

PARTS LIST

<u>SYMBOL</u>	<u>DESCRIPTION</u>	<u>SPECIFICATIONS</u>	<u>MANUFACTURER</u>	<u>MFGR PART NO.</u>	<u>NUCLEONIC STOCK NO.</u>
N/A	Tube lock for V1	Wire, Spring clamp	Tublok Mfg. Co. Palo Alto, Calif.	102W	RDA 72
N/A	Tube lock for V2	Wire, Spring clamp	Tublok Mfg. Co. Palo Alto, Calif.	103W	RDA 73
N/A	Knob for S1	Knob, selector	Davies Molding Corporation Chicago, Illinois	#1610	RDA 71
44 N/A	Lock and 2 keys for shipping and storage case	Padlock, 2 keys, per MIL Spec FFP-101C, Type EPB	Eagle Lock Mfg. Co. Terryville, Conn.	04875s	RDU-10
N/A	Absorber, flat, aluminum	Absorber, aluminum 4"x4"x1/32" thick	Nucleonic Corp. of America Brooklyn, N.Y.	RDU-1F	RDU-1F
N/A	Absorber, flat, cardboard	Absorber, cardboard 4"x4"x1/32" thick	Same as RDU-1F	RDU-1G	RDU-1G
N/A	Absorber, flat, lead	Absorber, lead, 4"x4"x 1/32" thick	Same as RDU-1F	RDU-1H	RDU-1H

Section 9

PARTS LIST

<u>SYMBOL</u>	<u>DESCRIPTION</u>	<u>SPECIFICATIONS</u>	<u>MANUFACTURER</u>	<u>MFGR PART NO.</u>	<u>NUCLEONIC STOCK NO.</u>
N/A	Absorber, cylindrical, aluminum	Absorber, aluminum 2" dia x 6" long x 1/32" thick	Same as RDU-1F	RDU-1I	RDU-1I
N/A	Absorber, cylindrical cardboard	Absorber, lead 2" dia x 6" long x 1/32" thick	Same as RDU-1F	RDU-1-J	RDU-1-J
N/A	Absorber, cylindrical, lead	Absorber, lead 2" dia x 6" long x 1/32" thick	Same as RDU-1F	RDU-1K	RDU-1K
N/A	Radium Beta-Gamma Source	Radium Beta-Gamma Source	Same as RDU-1F	RDU-1E	RDU-1E
R30	V1B grid resistor	Resistor, fixed, composition, 1K, 1/2W, +10%	Same as R1	Type EB	RDA69
TB7	Mounting Board for R30	Terminal Board	Cinch-Jones N.Y., N.Y.	51B	RDA70